

XLOCK 142

X LOCK



Installation Guide

PACKAGING CONTENTS

Lock with External
Antenna
XL142



4 x screws for lock,
countersunk head 3.5 x 35 mm.

Closing part
XL-S17



3 x screws for locking part
countersunk head 2.5 x 12 mm.

Always use lithium
batteries!

2 x CR123A ,
6V lithium batteries



Attention:
Please order batteries
separately.

DIMENSIONS

Lock
XL142

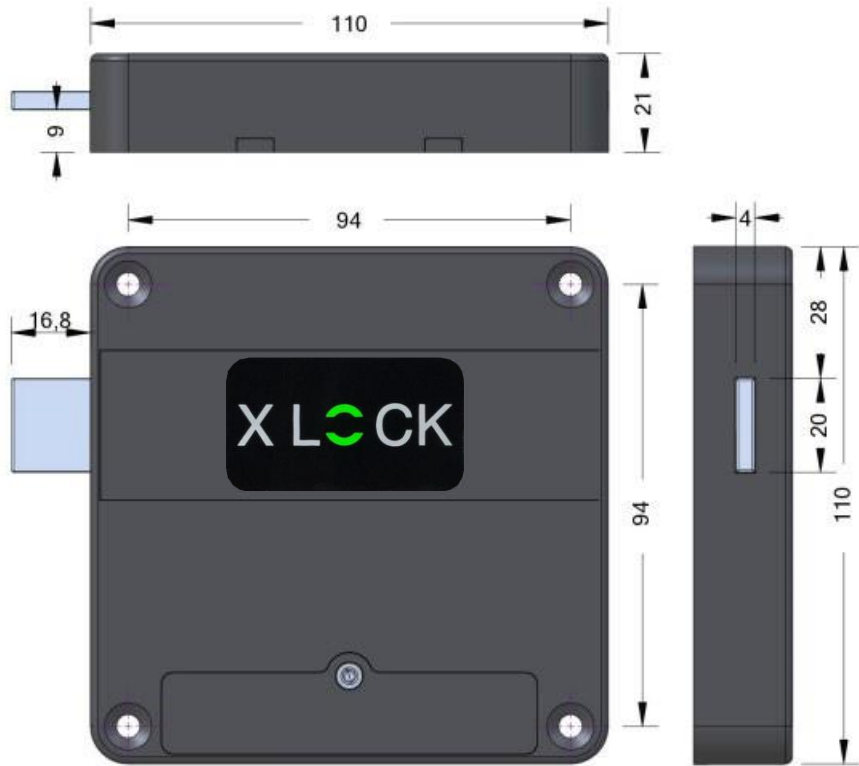

External
Antenna

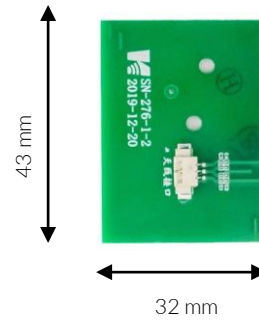

Closing part
XL-S17

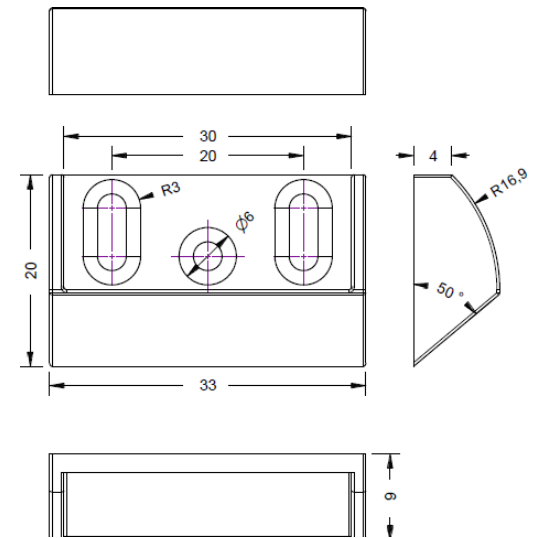

Optional ! Please order separately.



KEY FOB

XL-AUMIFCL-2

Encapsulated housing with stainless steel ring
RFID transponder ISO14443a type Mifare
Classic reading range up to 3cm



ISO ID-Card

XL-AUMIFCL

RFID card transponder ISO14443a
type Mifare Classic reading range
up to 2,5cm



KEY FOB

XL-SAMIFCL

Ultraviolet welded case with stainless
steel ring RFID transponder
ISO14443a type Mifare Classic reading
range up to 2,5cm

ANTENNA HOUSING with handle

Optional ! Please order separately.



XLOCK Antenna housing with handle
XL-A3B
without antenna and cable
Colour: Black



XLOCK Antenna housing with handle
XL-A3S
without antenna and cable
Colour: Gray



XLOCK Antenna housing with handle
XL-A3W
without antenna and cable
Colour: White

PREPARATION FROM THE LOCK



2 pieces CR123A, 6V lithium batteries.

For error-free operation, please always use lithium batteries!

Open the battery compartment cover and insert the batteries with the correct polarity (+/-).

Close the battery compartment cover and fix it with the screw.

Your lock is now ready for use.

INSTALL THE APP AND CREATE AN ACCOUNT



XL Lock Manager App and on the
Install smartphone (IOS + Android).

Simply scan the QR code with your camera:



After installation, create your XLOCK account
and confirm in the e-mail - > done.

Attention for Android devices:

For Android devices, the following permissions must be granted without restrictions for the commissioning of Bluetooth devices: **Location and Bluetooth**
In retrospect, this is no longer possible with some devices. Then you have to uninstall and reinstall the app and then restart the device.



For the commissioning of an XLOCK lock, the **location** and **Bluetooth** must be activated in the Android system!

CREATE ACCOUNT

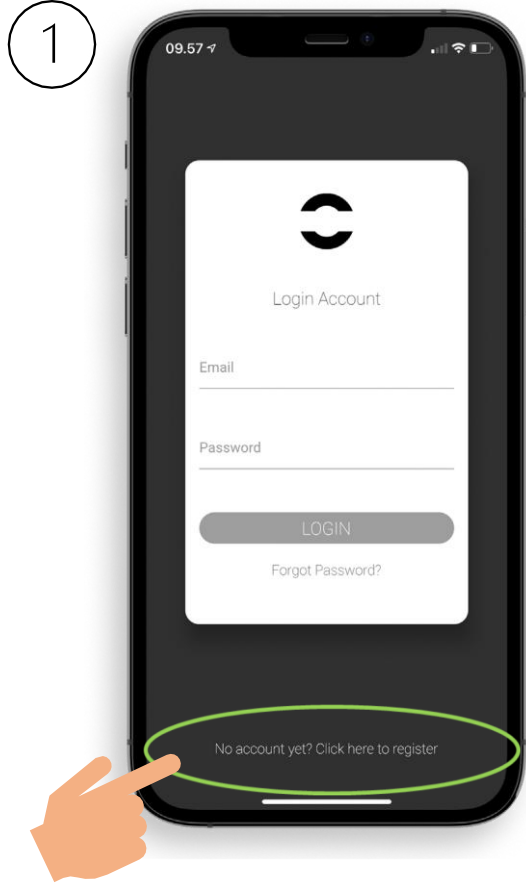

1. Tap the button above.

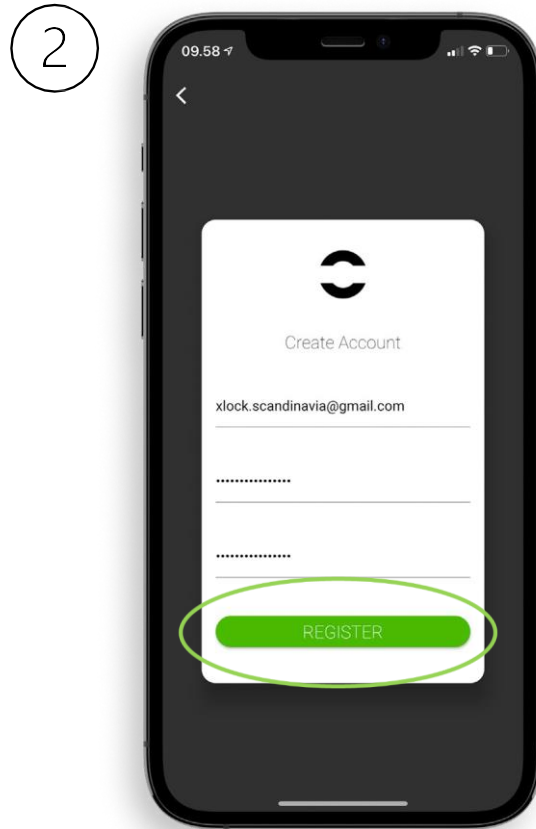

2. Enter your email address and choose a password. To confirm, password again type. Tap Register.

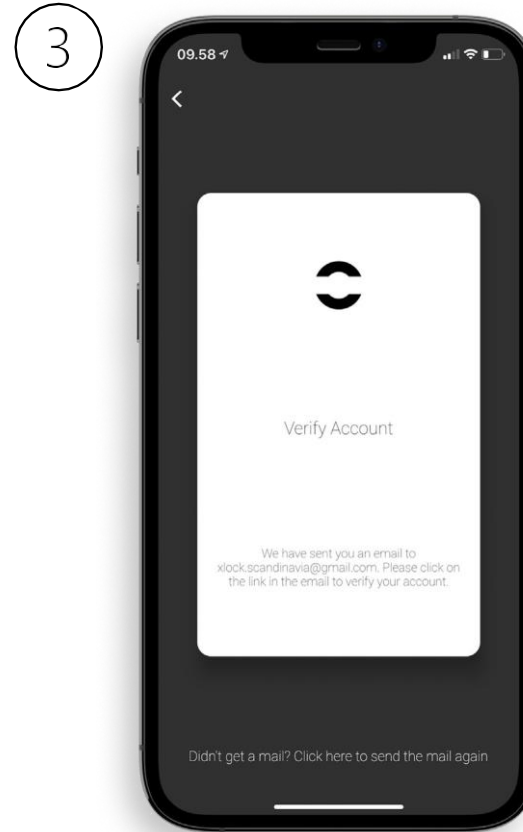

3. Verify your account by clicking on the confirmation link in the XLOCK e-mail in your e-mail inbox button. It may be that the confirmation email has landed in your spam folder.

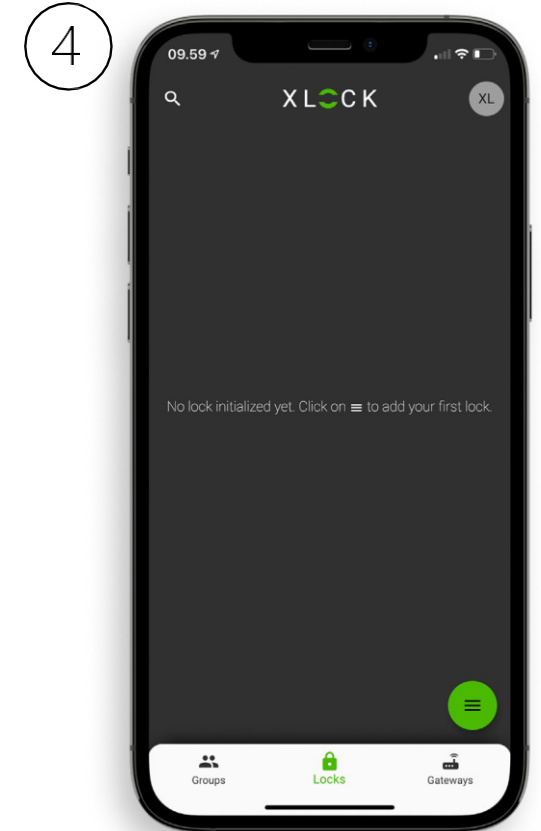

4. Congratulate! You have successfully installed the XL LOCK Manager app.

ADD NEW LOCK IN YOUR ACCOUNT

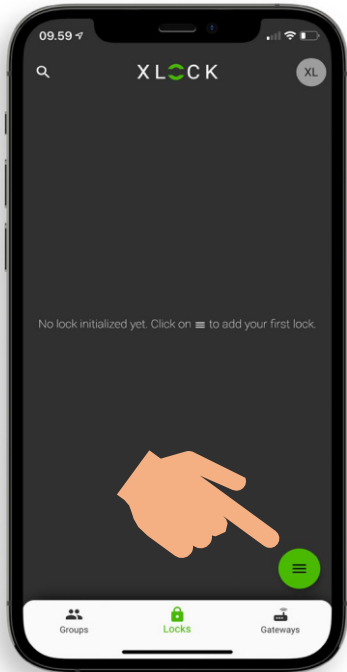

1. Tap the button at the bottom right corner.

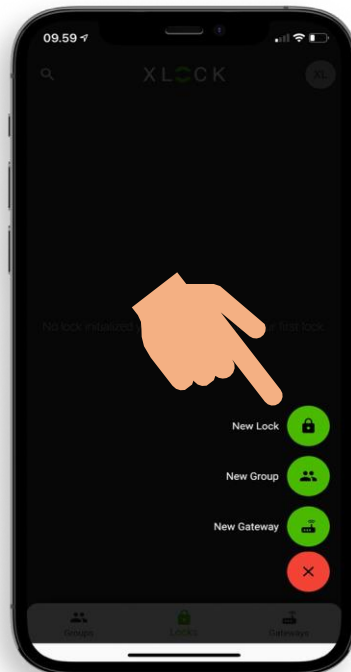

2. Tap **New Lock**.

3. Have XLOCK lock ready? Press and hold the reset button with a screwdriver.



4. The lock is displayed with its ID number. Tap on the green **+** one to add your XLOCK.

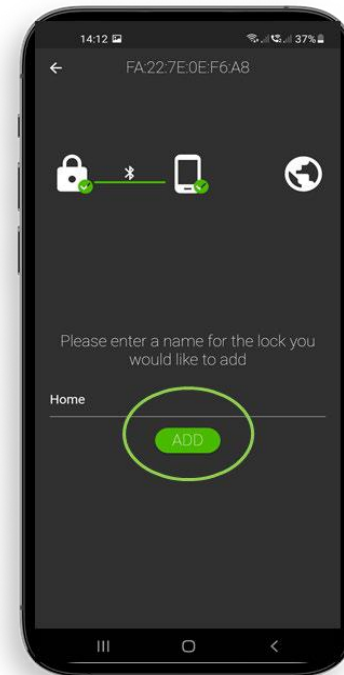

5. Give the lock a name and tap **ADD**.



6. The XLOCK lock has now been successfully linked to the XLOCK APP and is visible on the start screen.

ADD TRANSPONDERS

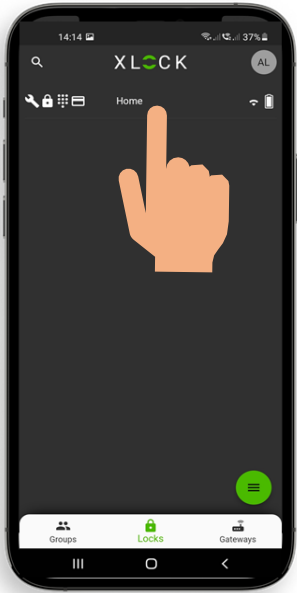

1. Tap the lock. The lock menu opens.

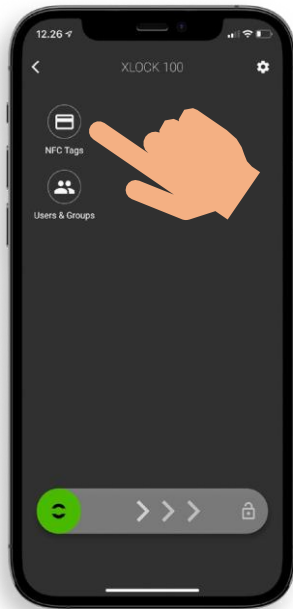

2. Tap the **NFC Tags** card icon.

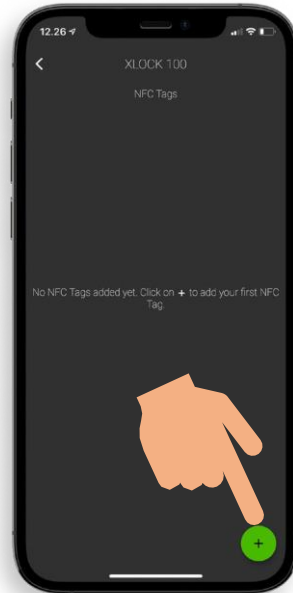

3) Tap that in the lower right corner to open the tag Add.

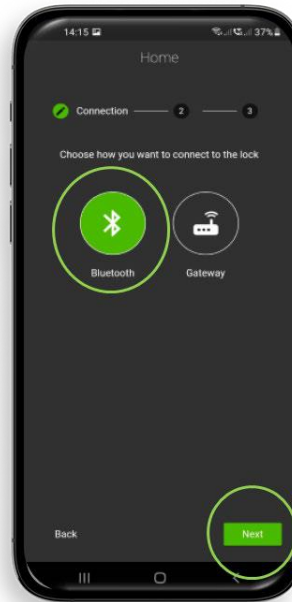

4) Select Bluetooth and tap **Next**.

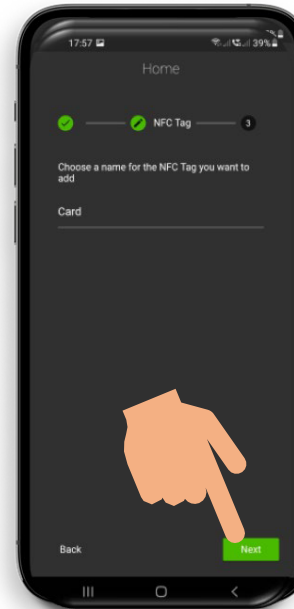

5) Give the transponder a name. Tap **Next**, the lock starts the learning process.

6) The lock signals when it is ready. Then, as shown in the photo, hold the transponder to the antenna from the lock.



7) Your transponder is now stored and unlocks the lock when held to the antenna.

UNLOCK and LOCK

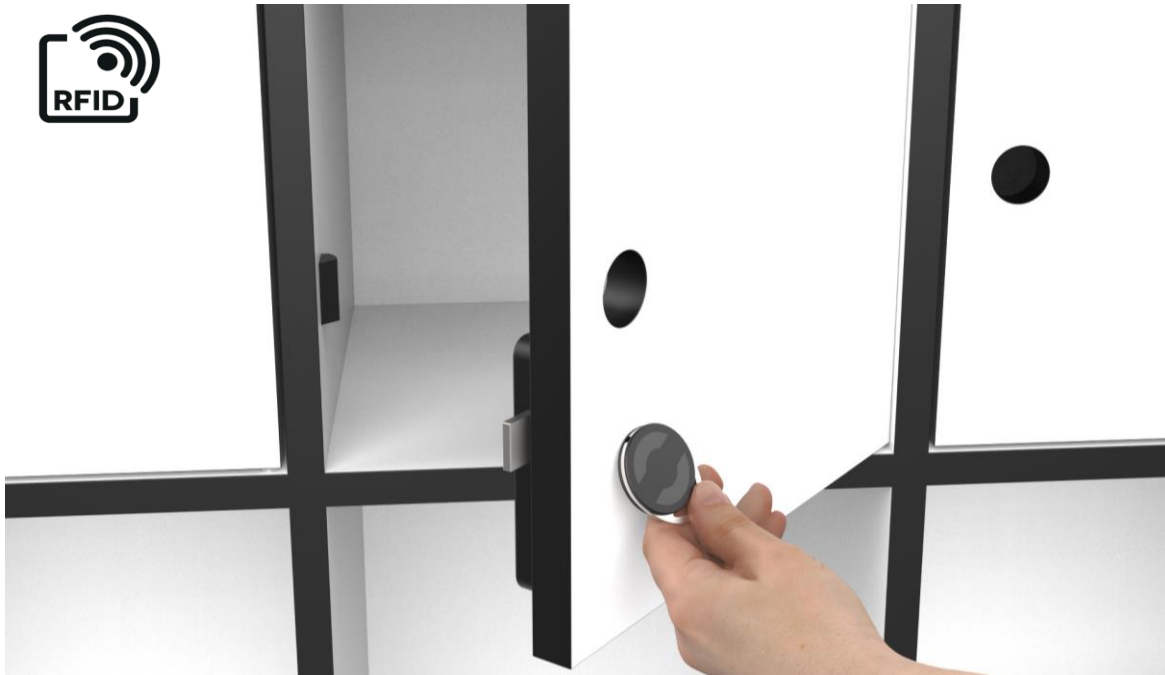

Hold a programmed transponder against the lock's antenna. The reading distance depends on the installation and the medium. The lock unlocks and the drawer can be opened. After 5 seconds, the lock locks automatically. The locking time can be adjusted in the app in the lock settings: 5-900 seconds



Unlocking with the smartphone and the app is very simple. A swipe to the right unlocks the lock for 5 seconds. The reading distance is up to 15 meters. Therefore, the lock can also be installed hidden, e.g. behind a drawer. The toggle mode (open-close function) can also be used with the smartphone. This function is activated and deactivated in the app in the lock menu.

VIEW MOUNTING LEFT / RIGHT

Left



Right



The direction of the locking latch can be changed, please specify when ordering.

XLOCK 142 MOUNTING LEFT

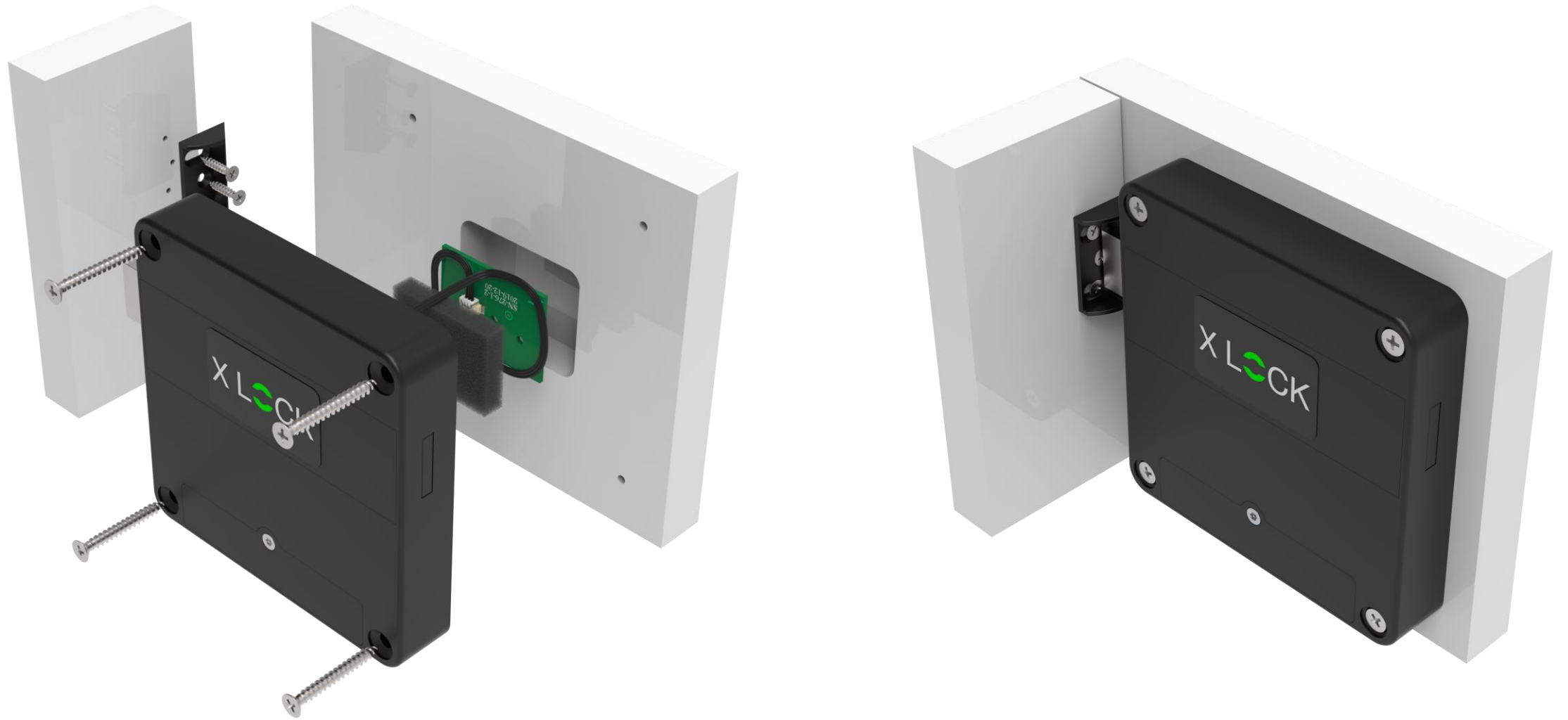

Mounting the lock

Tighten the screws with feeling and do not use drills or cordless drill or cordless screwdriver.

XLOCK 142 MOUNTING LEFT

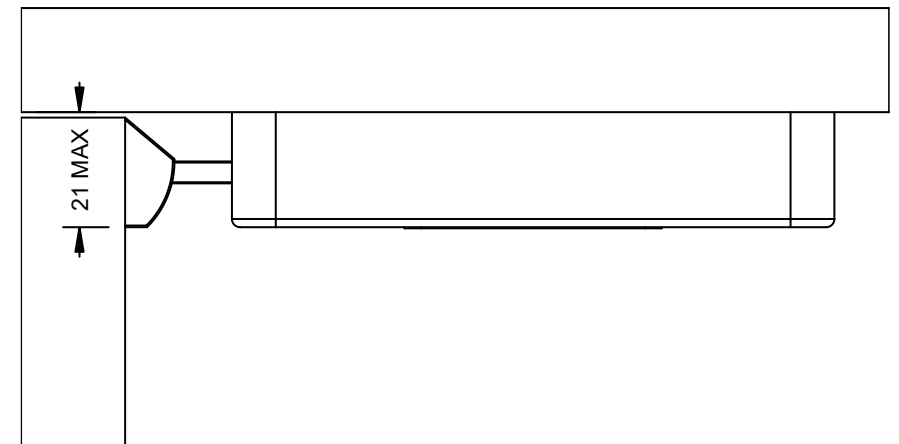
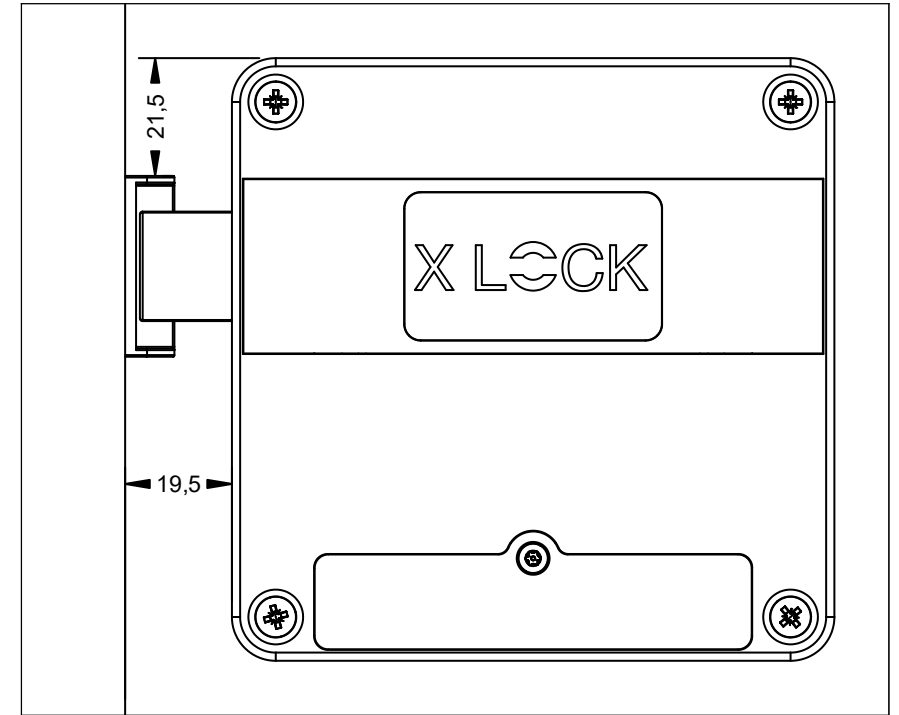
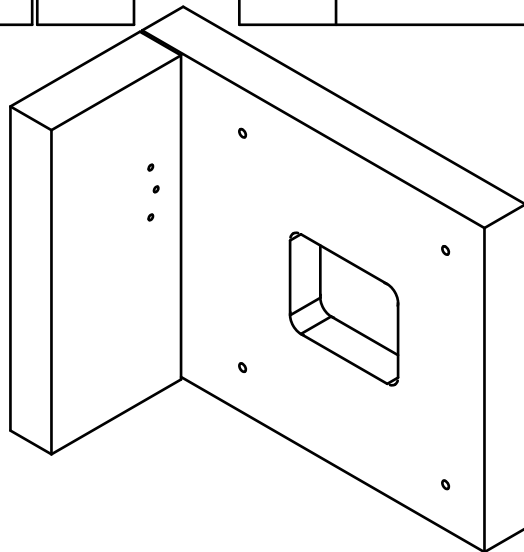
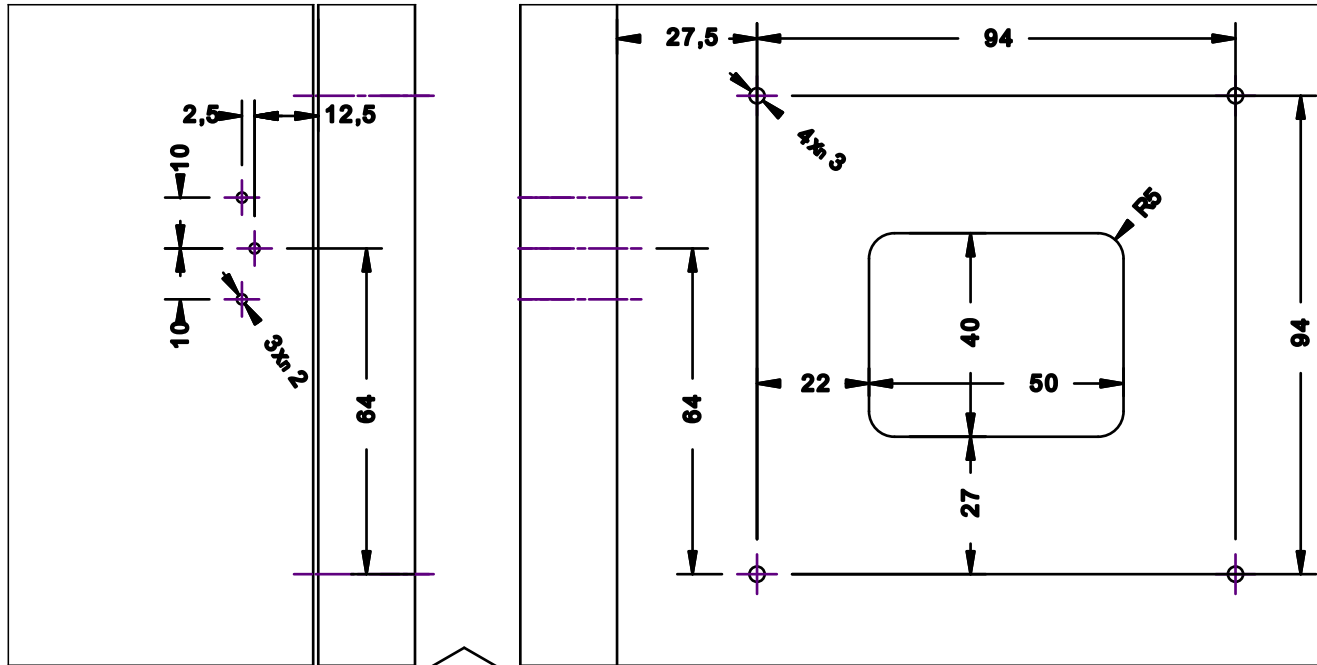

XLOCK 142 MOUNTING RIGHT

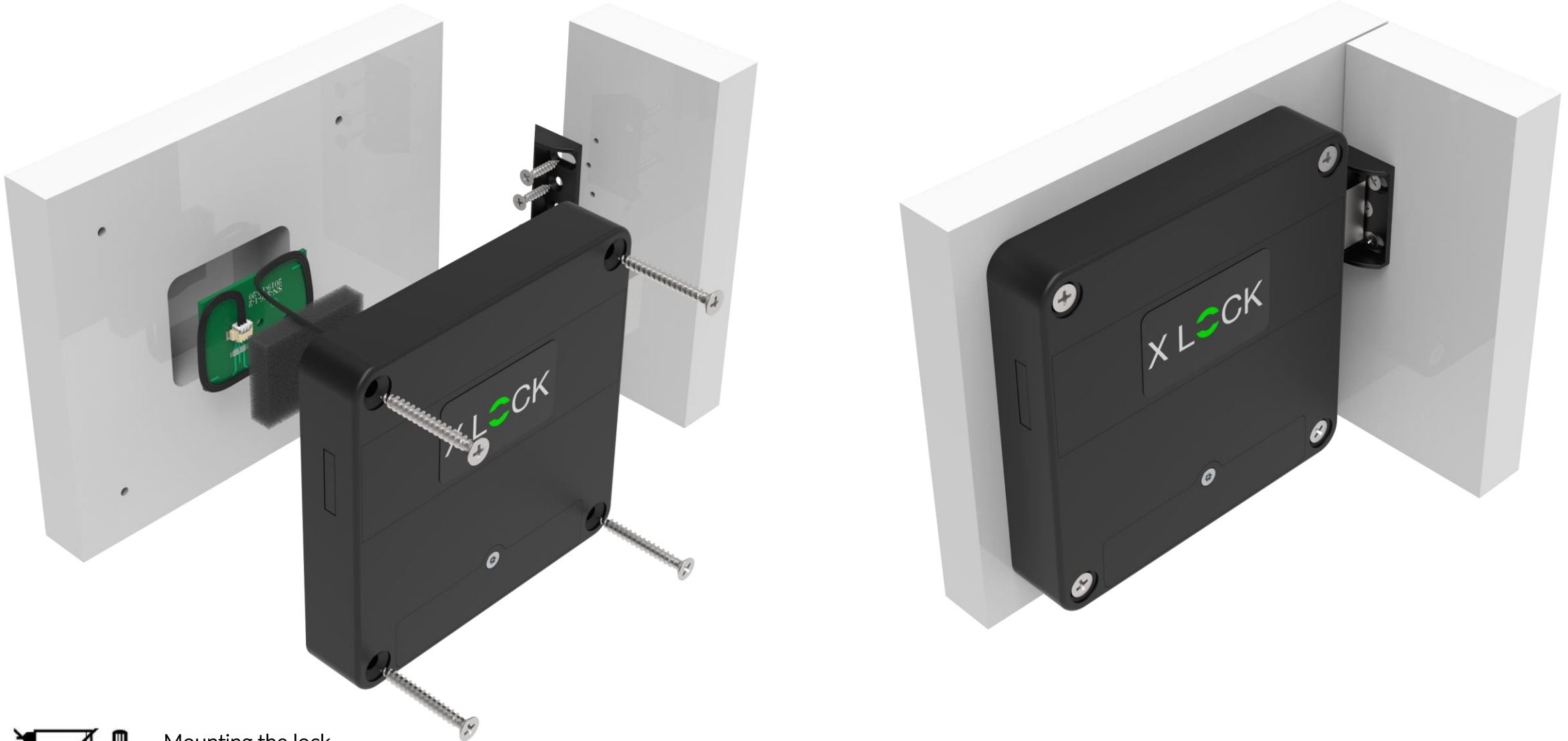

Mounting the lock
Tighten the screws with feeling and do not use drills or cordless
drill or cordless screwdriver.

XLOCK 142 MOUNTING RIGHT

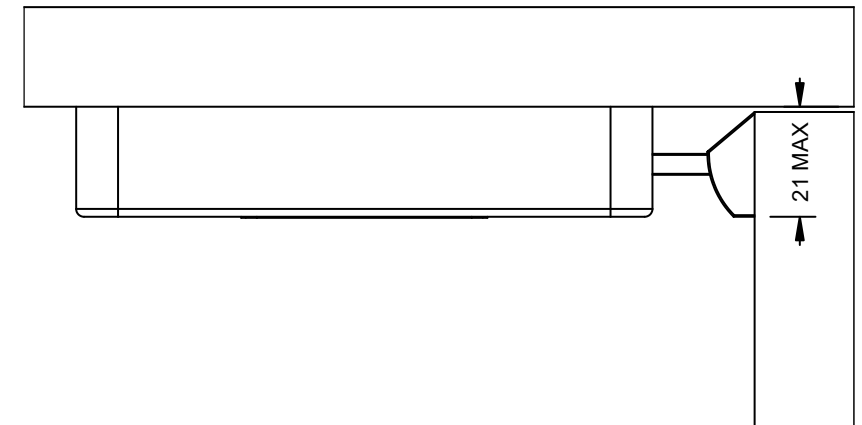
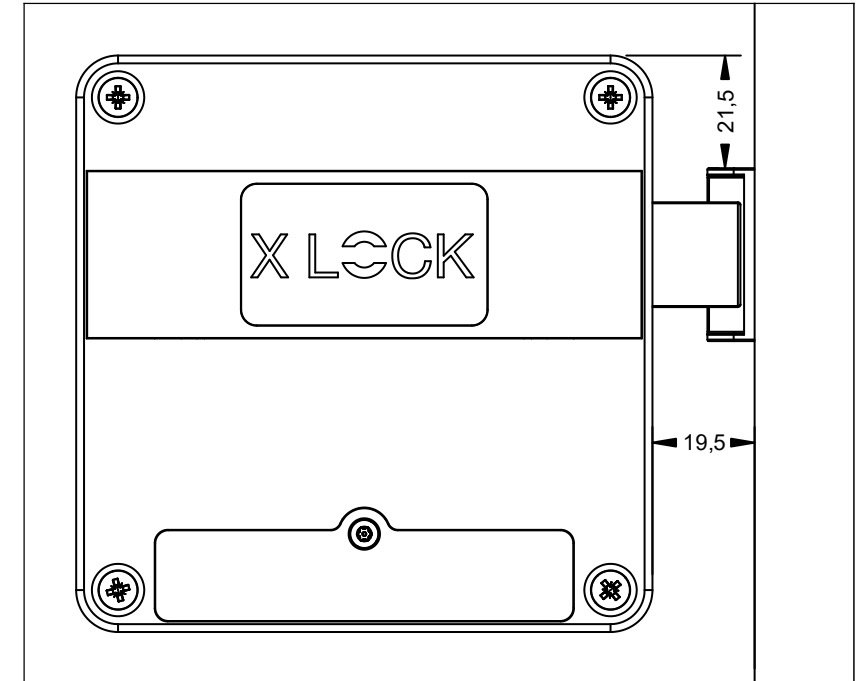
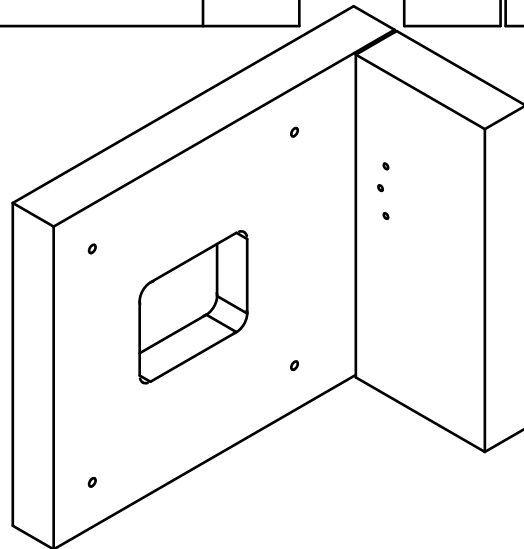
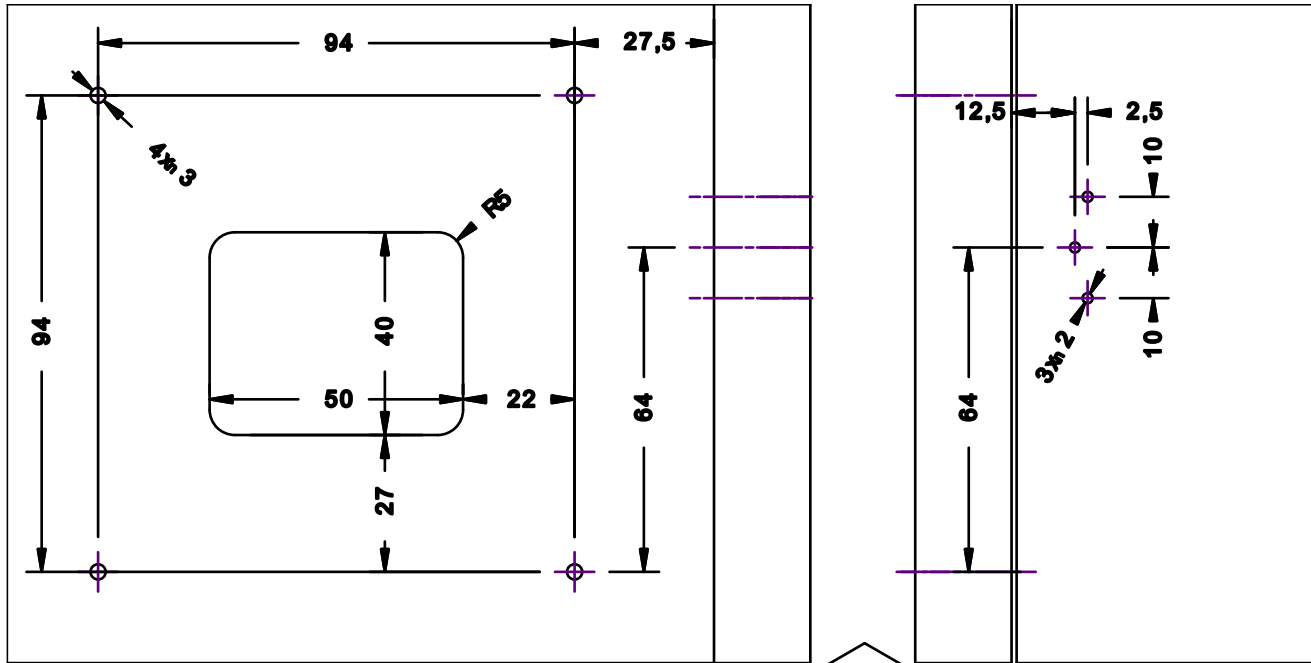

XLOCK GATEWAYS

Optional! Please order separately.



XLOCK Gateway G2-WIFI incl.
USB C charging cable.
2.4 GHz WIFI compatible USB
power supply required

 Bluetooth™



XLOCK Gateway G3-
Ethernet incl. USB C charging
cable.
USB power supply required

 Bluetooth™



XLOCK Gateway G3 POE-Ethernet
incl. USB C charging cable.
POE does not require a separate
power supply

 Bluetooth™



BLUETOOTH ACCESSORIES

Optional ! Please order separately.



With the Wireless Key and the Wireless Keypad, the lock can be unlocked over a distance of up to 20 meters - cable-free.



XLOCK BLE
Wireless key



XLOCK BLE
Wireless keypad



The wireless keypad can be used to program all XLOCK pin code functions such as fixed, time and one-time code.

XLOCK

More information and support at
www.xlockgroup.com

XLOCK by data mobile

Landstrasse 35-39

AUT - 6911 Lochau

info@xlockgroup.com

www.xlockgroup.com